



PDM INDUSTRIAL PRODUCTS, INC.

Laboratory & Industrial Furnishing Solutions...

METAL LABORATORY SYSTEMS



SEFA
SCIENTIFIC
EQUIPMENT &
FURNITURE
ASSOCIATION

QUALITY • SERVICE • TIMING

TABLE OF CONTENTS

Specifications-----	1
Base Cabinets - Standing/Counter Height-----	2 - 8
Base Cabinets - Sink/Fume Hood Standing Height-----	9
Base Cabinets - Special Purpose-----	10
Acid Storage Cabinets-----	11
Flammable Storage Cabinets-----	11
Base Cabinets - Sitting/Desk Height-----	12 - 14
Corner Base Cabinets - Sitting/Desk Height-----	15
Corner Sink Cabinets - Sitting/Desk Height-----	15
Wall Case Units-----	16 - 17
Corner Wall Case Units-----	17
Floor Case Units-----	18 - 19
Fume Hoods-----	20 - 21
Aprons and Drawer Housings-----	22
Utility Tables-----	23
Accessories-----	24 - 25

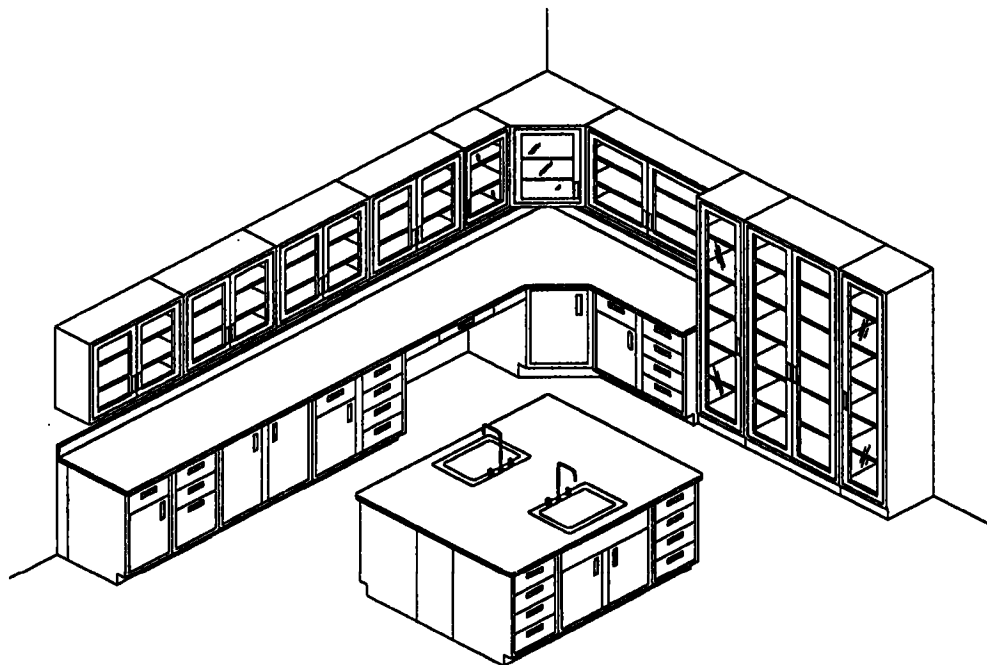

BASE CABINETS *Standing/Counter Height*

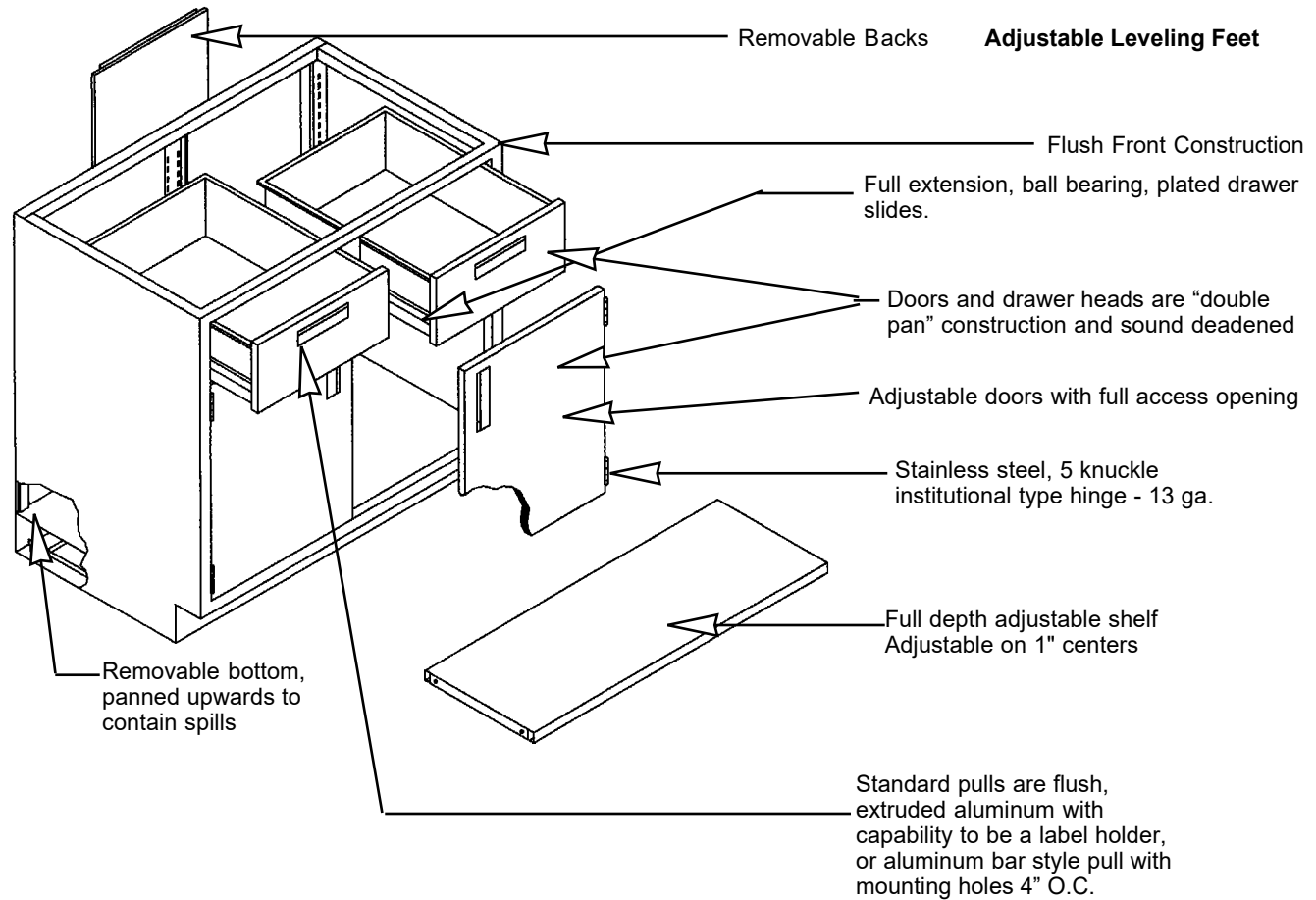

Additional Specifications

All surfaces shall be painted or zinc plated. The paint is a chemical resistant baked on epoxy powder. Specific test data is available upon request.

Gauges of base cabinet components are as follows:

Aprons	18 ga.	Legs - 2" sq. tube	18 ga.
Back Panels	20 ga.	Shelves	18 ga.
Bottom Panels	18 ga.	Side Panels	18 ga.
Drawer/Door Outer Panel	20 ga.	Table Frames	18 ga.
Door Inner Panel	20 ga.	K & V Shelf Clips	
Drawer Bodies	20 ga.		

NOTE: Cabinet Heights are 29" (Desk-Height) & 35" (Standard Height). Levelers extend 1-1/2".

See ADA-Height Metal laboratory Cabinets catalogue for 32.5" high cabinets.

Subject to change.

BASE CABINETS *Standing/Counter Height*

Standing/Counter Height 35"High (34.75"w/out Leveler) x 22"Deep. Units are available in various widths as shown. Drawer units feature full extension slides. A single shelf is standard in the units shown. Additional shelves are available (see

Part Numbering System

Sample: RB35H36W-048 1 = Base unit 4 = #Doors
 11222333-456 2 = Height 5 = #Drawers
 3 = Width 6 = #Half Drawers

- *"F" = File Drawer
- *"S" = Sink Unit
- *"P" = Panel
- *"R" = Right hinge facing cab.
- *"L" = Left hinge facing cab.

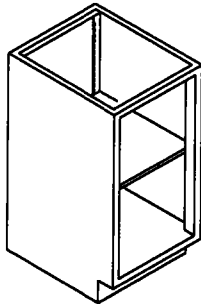
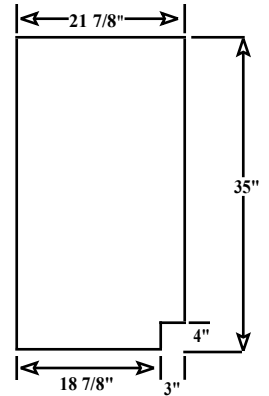

RB35H15W-000
RB35H18W-000
RB35H24W-000

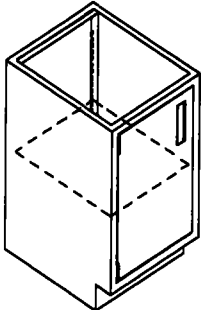

RB35H15W-100(L)
RB35H18W-100(L)
RB35H24W-100(L)

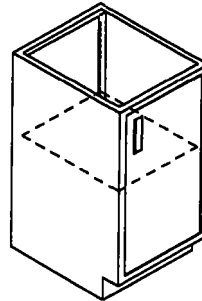

RB35H15W-100(R)
RB35H18W-100(R)
RB35H24W-100(R)

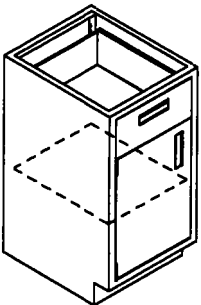

RB35W15H-110(L)
RB35W18H-110(L)
RB35W24H-110(L)

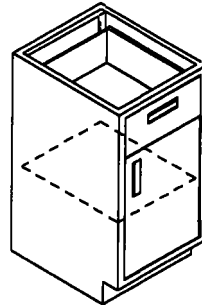

RB35H15W-110(R)
RB35H18W-110(R)
RB35H24W-110(R)

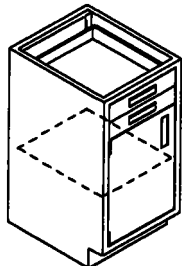

RB35H15W-102(L)
RB35H18W-102(L)
RB35H24W-102(L)

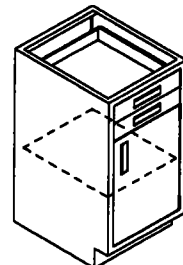

RB35H15W-102(R)
RB35H18W-102(R)
RB35H24W-102(R)

NOTE: When ordering units with configurations that are non-standard, drawings must accompany order.

BASE CABINETS *Standing/Counter Height*

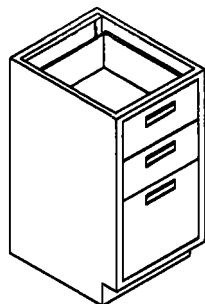

**RB35H15W-F20
RB35H18W-F20
RB35H24W-F20**

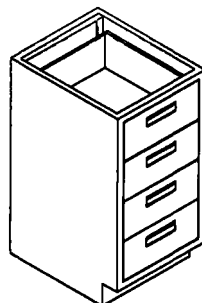

**RB35H15W-040
RB35H18W-040
RB35H24W-040**

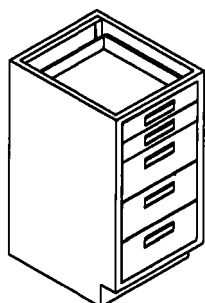

**RB35H15W-032
RB35H18W-032
RB35H24W-032**

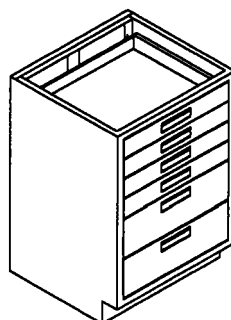

**RB35H15W-024
RB35H18W-024
RB35H24W-024**

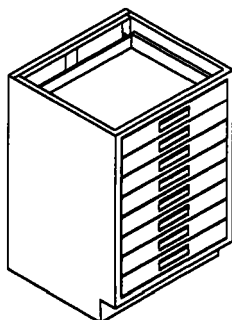

**RB35H15W-008
RB35H18W-008
RB35H24W-008**

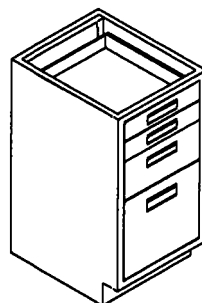

**RB35H15W-F12
RB35H18W-F12
RB35H24W-F12**

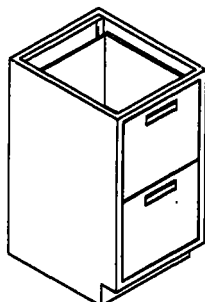

**RB35H15W-FFO
RB35H18W-FFO
RB35H24W-FFO**

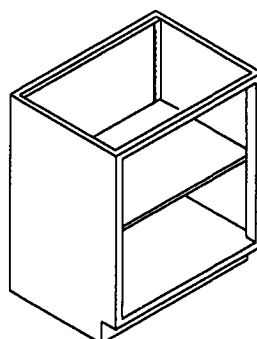

**RB35H30W-000
RB35H36W-000
RB35H42W-000
RB35H48W-000**

BASE CABINETS *Standing/Counter Height*

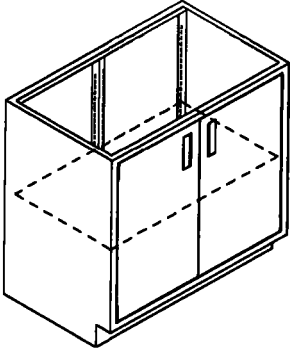

**RB35H30W-200
RB35H36W-200
RB35H42W-200
RB35H48W-200**



**RB35H30W-110(L)SP
RB35H36W-110(L)SP
RB35H42W-110(L)SP
RB35H48W-110(L)SP**

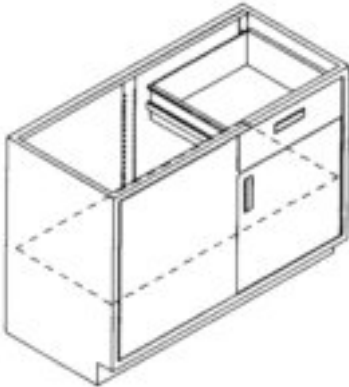

**RB35H30W-110(R)SP
RB35H36W-110(R)SP
RB35H42W-110(R)SP
RB35H48W-110(R)SP**
NOTE: 1/2 CAB+1" Exposed

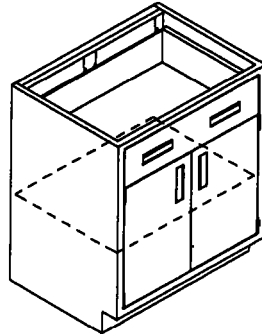

**RB35H30W-210
RB35H36W-210
RB35H42W-210
RB35H48W-210**

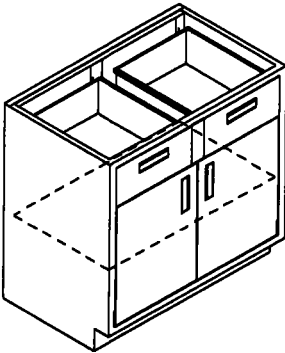

**RB35H30W-220
RB35H36W-220
RB35H42W-220
RB35H48W-220**

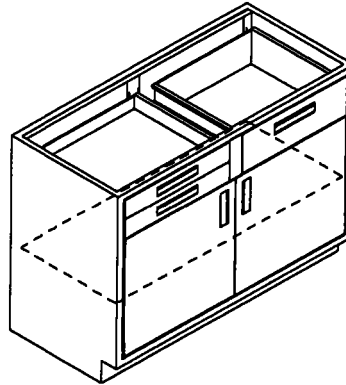

**RB35H30W-212A
RB35H36W-212A
RB35H42W-212A
RB35H48W-212A**

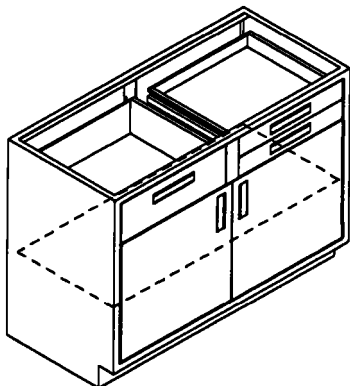

**RB35H30W-212B
RB35H36W-212B
RB35H42W-212B
RB35H48W-212B**

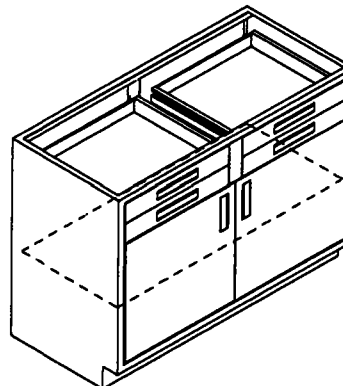

**RB35H30W-204
RB35H36W-204
RB35H42W-204
RB35H48W-204**

BASE CABINETS *Standing/Counter Height*

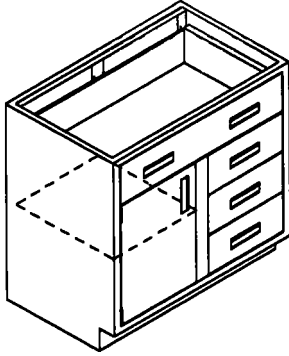

RB35H30W-140B(L)
 RB35H36W-140B(L)
 RB35H42W-140B(L)
 RB35H48W-140B(L)

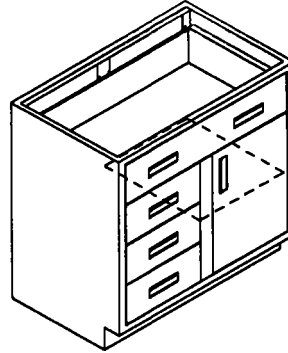

RB35H30W-140B(R)
 RB35H36W-140B(R)
 RB35H42W-140B(R)
 RB35H48W-140B(R)

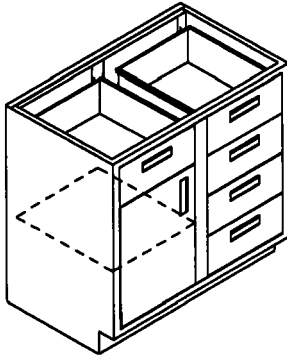

RB35H30W-150(L)
 RB35H36W-150(L)
 RB35H42W-150(L)
 RB35H48W-150(L)

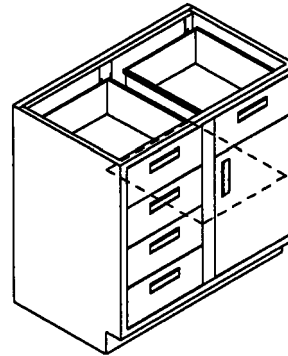

RB35H30W-150(R)
 RB35H36W-150(R)
 RB35H42W-150(R)
 RB35H48W-150(R)

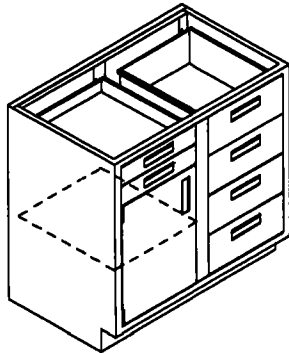

RB35H30W-142(L)
 RB35H36W-142(L)
 RB35H42W-142(L)
 RB35H48W-142(L)

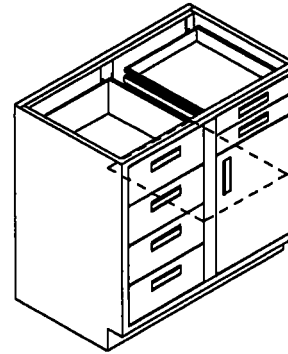

RB35H30W-142(R)
 RB35H36W-142(R)
 RB35H42W-142(R)
 RB35H48W-142(R)

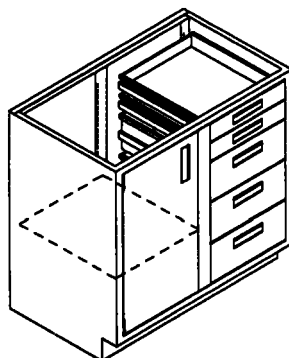

RB35H30W-132(L)
 RB35H36W-132(L)
 RB35H42W-132(L)
 RB35H48W-132(L)

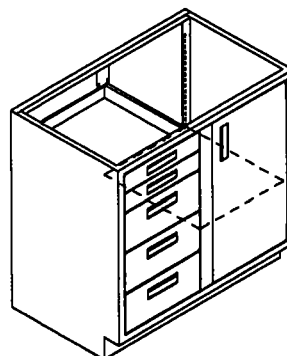

RB35H30W-132(R)
 RB35H36W-132(R)
 RB35H42W-132(R)
 RB35H48W-132(R)

BASE CABINETS *Standing/Counter Height*

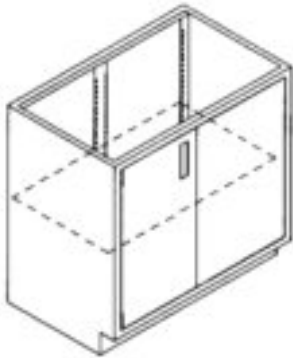

RB35H30W-100(L)SP
 RB35H36W-100(L)SP
 RB35H42W-100(L)SP
 RB35H48W-100(L)SP

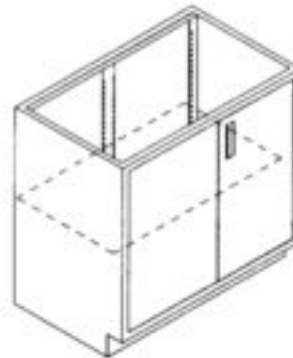

RB35H30W-100(R)SP
 RB35H36W-100(R)SP
 RB35H42W-100(R)SP
 RB35H48W-100(R)SP

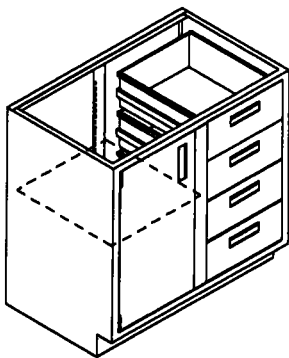

RB35H30W-140A(L)
 RB35H36W-140A(L)
 RB35H42W-140A(L)
 RB35H48W-140A(L)

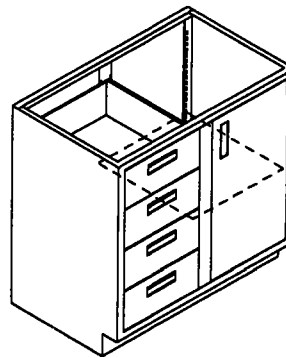

RB35H30W-140A(R)
 RB35H36W-140A(R)
 RB35H42W-140A(R)
 RB35H48W-140A(R)

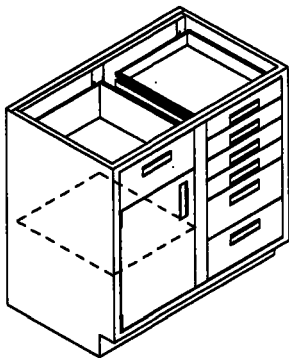

RB35H30W-134(L)
 RB35H36W-134(L)
 RB35H42W-134(L)
 RB35H48W-134(L)

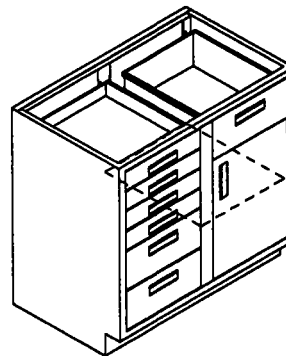

RB35H30W-134(R)
 RB35H36W-134(R)
 RB35H42W-134(R)
 RB35H48W-134(R)

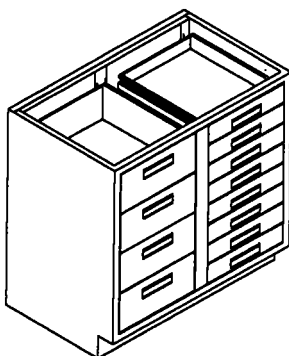

RB35H30W-048A
 RB35H36W-048A
 RB35H42W-048A
 RB35H48W-048A

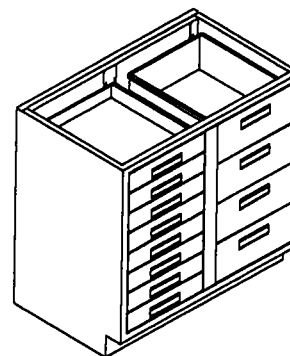

RB35H30W-048B
 RB35H36W-048B
 RB35H42W-048B
 RB35H48W-048B

NOTE: When ordering units with configurations that are non-standard, drawings must accompany order.

BASE CABINETS *Standing/Counter Height*

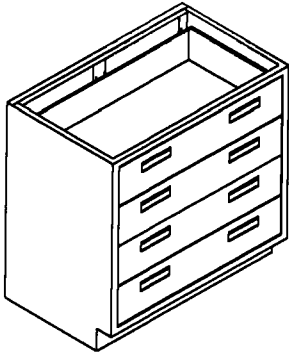

RB35H30W-040
RB35H36W-040
RB35H42W-040
RB35H48W-040
NOTE: Drawer I.D.:
Width=CABWidth-4.875
Depth=19.5"D

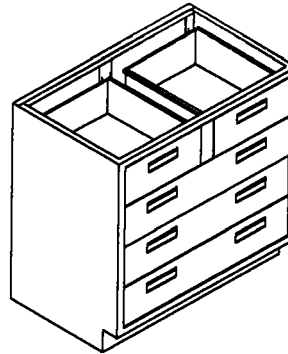

RB35H30W-050
RB35H36W-050
RB35H42W-050
RB35H48W-050

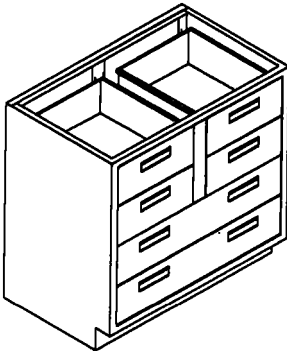

RB35H30W-060
RB35H36W-060
RB35H42W-060
RB35H48W-060

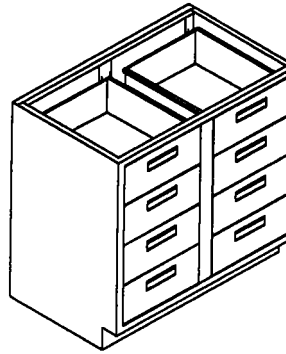

RB35H30W-080
RB35H36W-080
RB35H42W-080
RB35H48W-080

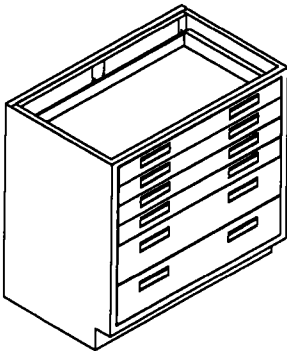

RB35H30W-024
RB35H36W-024
RB35H42W-024
RB35H48W-024

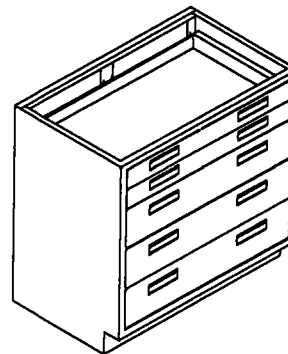

RB35H30W-032
RB35H36W-032
RB35H42W-032
RB35H48W-032

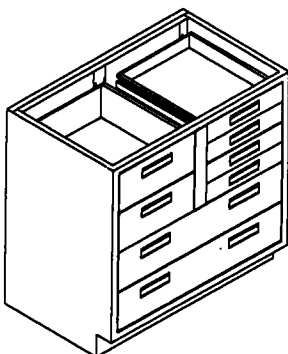

RB35H30W-044A
RB35H36W-044A
RB35H42W-044A
RB35H48W-044A

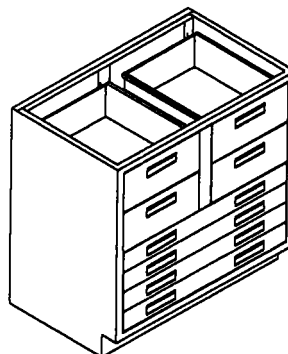

RB35H30W-044B
RB35H36W-044B
RB35H42W-044B
RB35H48W-044B

BASE CABINETS *Standing/Counter Height*

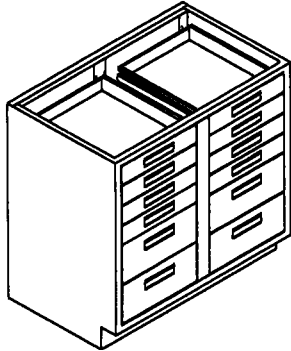

RB35H30W-048C
 RB35H36W-048C
 RB35H42W-048C
 RB35H48W-048C

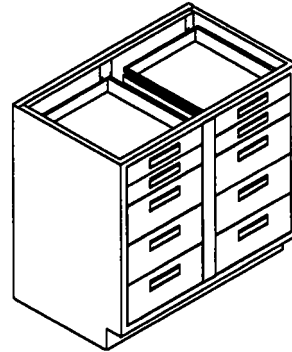

RB35H30W-064
 RB35H36W-064
 RB35H42W-064
 RB35H48W-064

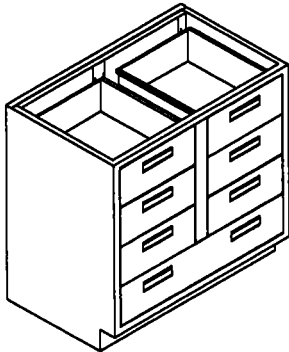

RB35H30W-070A
 RB35H36W-070A
 RB35H42W-070A
 RB35H48W-070A

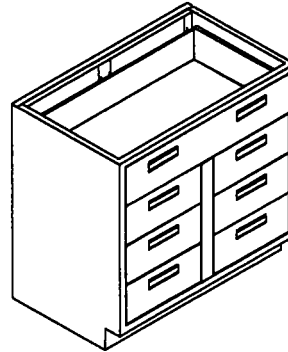

RB35H30W-070B
 RB35H36W-070B
 RB35H42W-070B
 RB35H48W-070B

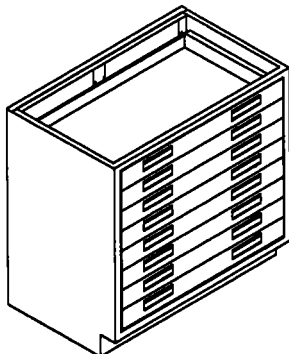

RB35H30W-008
 RB35H36W-008
 RB35H42W-008
 RB35H48W-008

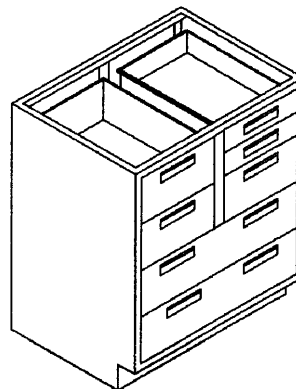

RB35H30W-052
 RB35H36W-052
 RB35H42W-052
 RB35H48W-052

NOTE: When ordering units with configurations that are non-standard, drawings must accompany order.

SINK AND FUME HOOD BASE CABINETS *Stand Up Height*

ALSO AVAILABLE IN SITTING/DESK HEIGHT



Sink Base
RB35H18W-10S(R)
RB35H24W-10S(R)



Sink Base
RB35H18W-10S(L)
RB35H24W-10S(L)



Sink Base
RB35H18W-10S(R)
Louvered
RB35H24W-10S(R)
Louvered



Sink Base
RB35H18W-10S(L)
Louvered
RB35H24W-10S(L)
Louvered



Hood Base
RB35H18W-10P(R)
RB35H24W-10P(R)



Hood Base
RB35H18W-10P(L)
RB35H24W-10P(L)

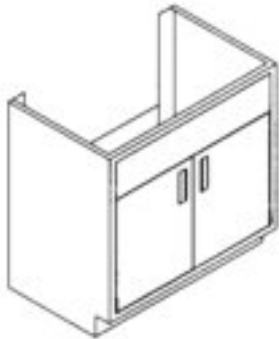

Sink Base
RB35H30W-20S
RB35H36W-20S
RB35H42W-20S
RB35H48W-20S
RB35H52W-20S
RB35H58W-20S

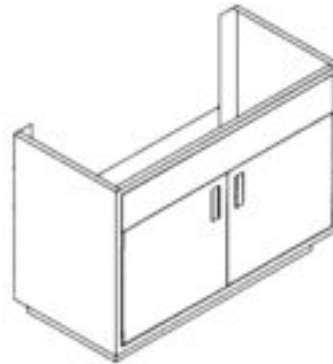

Sink Island Base
RB35H48W-20SI
RB35H52W-20SI
RB35H58W-20SI



Sink Base
RB35H30W-20S Louvered
RB35H36W-20S Louvered
RB35H42W-20S Louvered
RB35H48W-20S Louvered
RB35H52W-20S Louvered
RB35H58W-20S Louvered



Hood Base
RB35H30W-20P
RB35H36W-20P
RB35H42W-20P
RB35H48W-20P
RB35H52W-20P
RB35H58W-20P



Hood Island Base
RB35H52W-20PI
RB35H58W-20PI

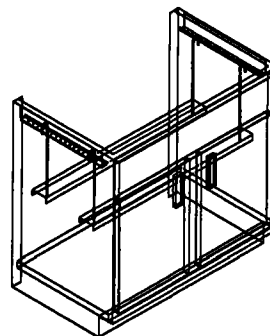

Sink Support Assembly
SS-36
SS-C14 SS-48
SS-18 SS-42
SS-24 SS-52

BASE CABINETS *Corner Unit Bases – w/ Removable Backs*

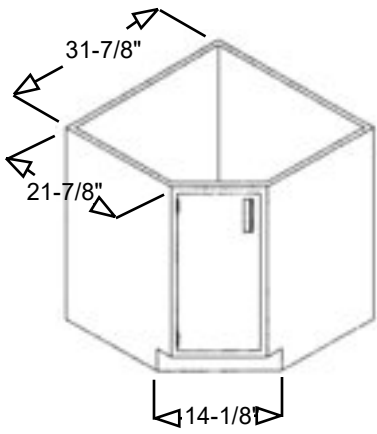

Typical Dimensions

RC35H14W-100(L)



RC35H14W-100(R)
*(SHOWN WITH
OPTIONAL LAZY
SUSAN INSTALLED)*



RC35H14W-10S(L)



RC35H14W-10S(R)



RC35H14W-10S(L)
Louvered



RC35H14W-10S(R)
Louvered

MOBILE BASES

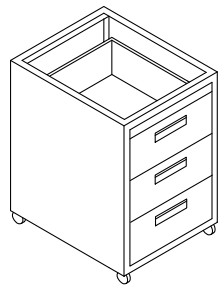

RMB29H15W-030
RMB29H18W-030
RMB29H24W-030
RMB29H30W-030

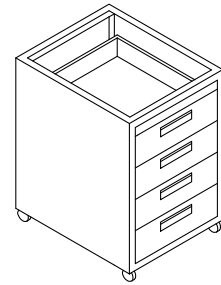

RMB35H15W-040
RMB35H18W-040
RMB35H24W-040
RMB35H30W-040

NOTE: 3" Casters (4" O.H.) can be added to Any Cabinet Style in lieu of Toe Kick Base. Be sure to add back panel if creating mobile modular pedestal style cabinet.

BASE CABINETS *Sitting / Desk Height*

Sitting/Desk Height 29" High X 22" Deep. Units are available in various widths as shown. Drawer units feature full extension slides. A single shelf is standard in the units where shown. Additional shelves are available (see page 11). Specify left or right hand doors. Hand is indicated by side of door upon which hinges are located.

Part Numbering System

- | | | | |
|---------|--------------|--------------|------------------|
| Sample: | RB29H30W-044 | 1= Base Unit | 4= #Doors |
| | 11222333-456 | 2= Height | 5= #Drawers |
| | | 3= Width | 6= #Half Drawers |
| | | | 7= Features |
- * "F" = File Drawer
 - * "S" = Sink Unit
 - * "P" = Panel over door(s)
 - * "R" = Right hinge facing cab.
 - * "L" = Left hinge facing cab.
 - * "B" = Bin Drawer

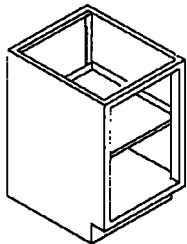
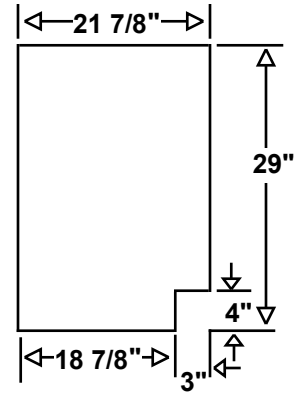

- RB29H15W-000
- RB29H18W-000
- RB29H24W-000
- RB29H30W-000
- RB29H36W-000
- RB29H42W-000
- RB29H48W-000

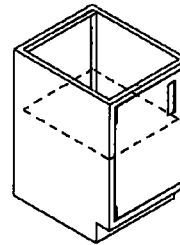

End View

- RB29H15W-100(L)
- RB29H18W-100(L)
- RB29H24W-100(L)

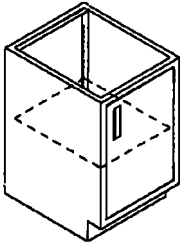

- RB29H15W-100(R)
- RB29H18W-100(R)
- RB29H24W-100(R)

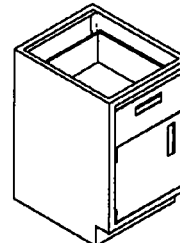

- RB29H15W-110(L)
- RB29H18W-110(L)
- RB29H24W-110(L)

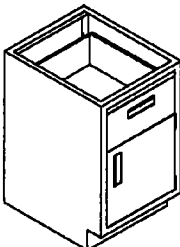

- RB29H15W-110(R)
- RB29H18W-110(R)
- RB29H24W-110(R)

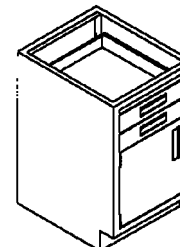

- RB29H15W-102(L)
- RB29H18W-102(L)
- RB29H24W-102(L)

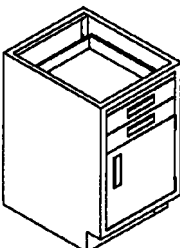

- RB29H15W-102(R)
- RB29H18W-102(R)
- RB29H24W-102(R)

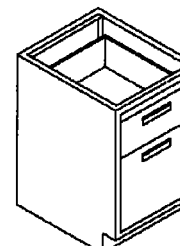

- RB29H15W-F10
- RB29H18W-F10
- RB29H24W-F10

NOTE: When ordering units with configurations that are non-standard, drawings must accompany order.

BASE CABINETS *Sitting / Desk Height*

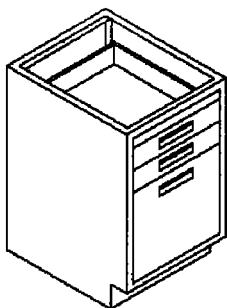

RB29H15W-F02
RB29H18W-F02
RB29H24W-F02

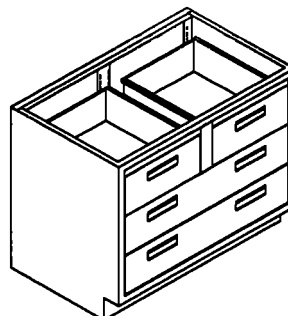

RB29H30W-040
RB29H36W-040
RB29H42W-040
RB29H48W-040

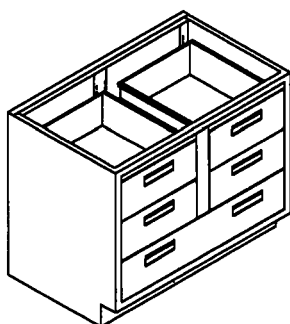

RB29H30W-050
RB29H36W-050
RB29H42W-050
RB29H48W-050

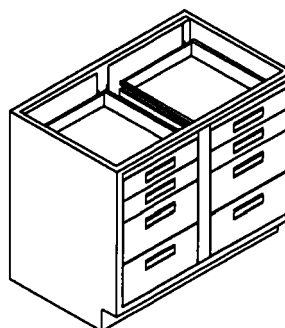

RB29H30W-044
RB29H36W-044
RB29H42W-044
RB29H48W-044

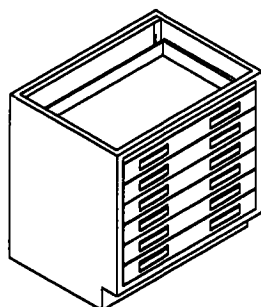

RB29H30W-006
RB29H36W-006
RB29H42W-006
RB29H48W-006

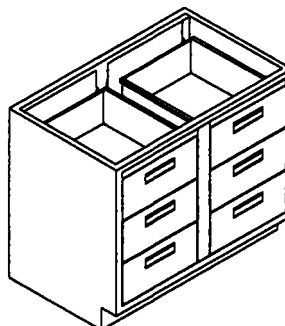

RB29H30W-060
RB29H36W-060
RB29H42W-060
RB29H48W-060

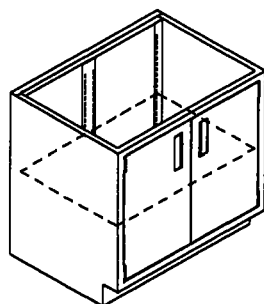

RB29H30W-200
RB29H36W-200
RB29H42W-200
RB29H48W-200

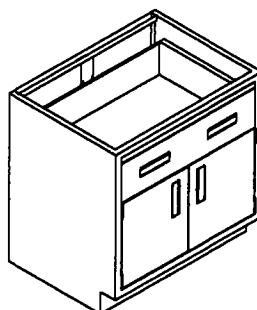

RB29H30W-210
RB29H36W-210
RB29H42W-210
RB29H48W-210

BASE CABINETS *Sitting / Desk Height*

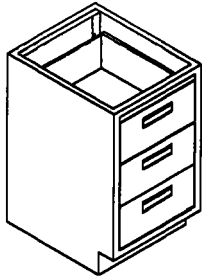

**RB29H15W-030
RB29H18W-030
RB29H24W-030**

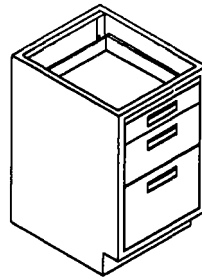

**RB29H15W-B11
RB29H18W-B11
RB29H24W-B11**

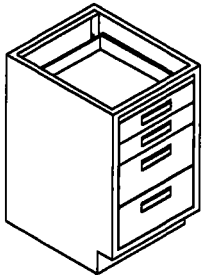

**RB29H15W-022
RB29H18W-022
RB29H24W-022**

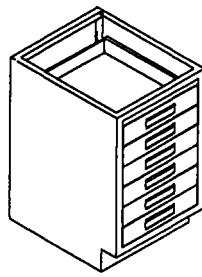

**RB29H15W-006
RB29H18W-006
RB29H24W-006**

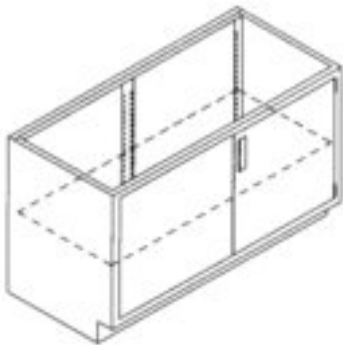

**RB29H30W-100(RorL)SP
RB29H36W-100(RorL)SP
RB29H42W-100(RorL)SP
RB29H48W-100(RorL)SP**

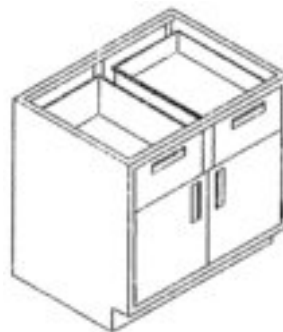

**RB29H30W-220
RB29H36W-220
RB29H42W-220
RB29H48W-220**



**RB29H30W-110(R)SP
RB29H36W-110(R)SP
RB29H42W-110(R)SP
RB29H48W-110(R)SP**



**RB29H30W-110(L)SP
RB29H36W-110(L)SP
RB29H42W-110(L)SP
RB29H48W-110(L)SP**

CORNER BASE CABINETS *Sitting / Desk Height*

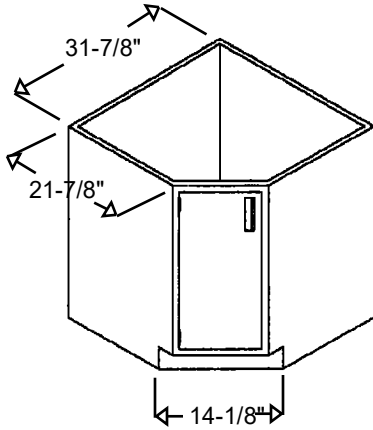

Typical Dimensions

RC29H14W-100(L)

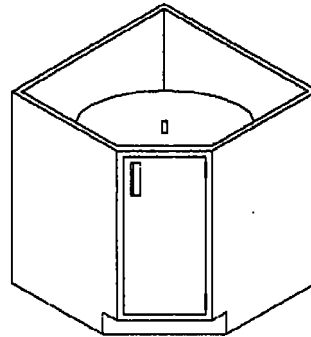

RC29H14W-100(R)

(SHOWN WITH OPTIONAL LAZY SUSAN INSTALLED)

CORNER SINK BASE CABINETS *Sitting / Desk Height*

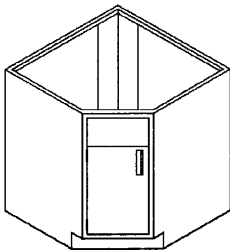

RC29H14W-10S(L)

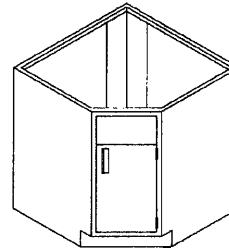

RC29H14W-10S(R)

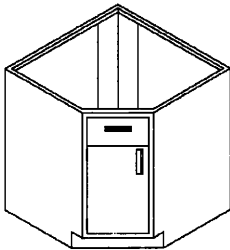

RC29H14W-10S(L)
Louvered

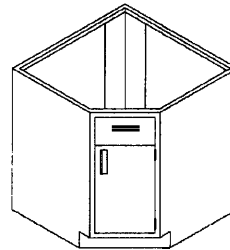

RC29H14W-10S(R)
Louvered

OPTIONAL LAZY SUSAN *(For corner base cabinets)*

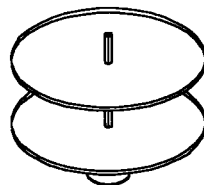

RLS-29H
RLS-35H

WALL CASE UNITS

Wall cases are available in sizes ranging from 24", 31", 36" and 48" high and 18" wide to 48" wide. All units are 13" deep (11.75" deep I.D. w/ 10.5" D Shelves) as standard. 24" high units have one shelf. 31" high to 36" high units have two shelves. 48" high units have three shelves. Additional shelves are available. On single hinge door units, specify (R) or (L) hinge. 48" high units have 3 hinges per door.

Part Numbering System

Sample: RW30H36W-2GS 1= Wall Case 4= #Doors
 11222333-4567 2= Height 5= Material of doors*
 3= Width 6= Type of doors* *

- * Steel, Glass or no doors (open)
- ** Hinged, Sliding or Sliding/framed
- * "R" = Right hinge facing cabinet
- * "L" = Left hinge facing cabinet

7= Depth Note: 13" dp. standard,
 16" deep cabinets available -
 indicate by final suffix of 16,
 (Example: RW24H18W-00016)

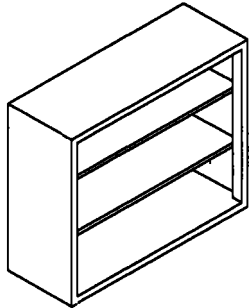

OPEN SHELVING UNITS:

RW24H18W-000	RW30H18W-000	RW36H18W-000	RW48H18W-000
RW24H24W-000	RW30H24W-000	RW36H24W-000	RW48H24W-000
RW24H30W-000	RW30H30W-000	RW36H30W-000	RW48H30W-000
RW24H36W-000	RW30H36W-000	RW36H36W-000	RW48H36W-000
RW24H42W-000	RW30H42W-000	RW36H42W-000	RW48H42W-000
RW24H48W-000	RW30H48W-000	RW36H48W-000	RW48H48W-000

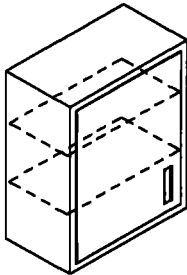

STEEL DOOR HINGED LEFT:

RW24H18W-1SH(L)	RW30H18W-1SH(L)
RW36H18W-1SH(L)	RW48H18W-1SH(L)
RW24H24W-1SH(L)	RW30H24W-1SH(L)
RW36H24W-1SH(L)	RW48H24W-1SH(L)

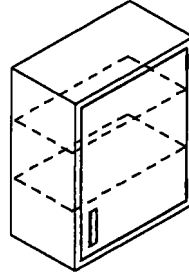

STEEL DOOR HINGED RIGHT:

RW24H18W-1SH(R)	RW30H18W-1SH(R)
RW36H18W-1SH(R)	RW48H18W-1SH(R)
RW24H24W-1SH(R)	RW30H24W-1SH(R)
RW36H24W-1SH(R)	RW48H24W-1SH(R)

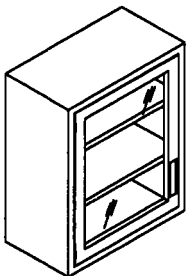

GLASS W/ FRAME HINGED LEFT:

RW24H18W-1GH(L)	RW30H18W-1GH(L)
RW36H18W-1GH(L)	RW48H18W-1GH(L)
RW24H24W-1GH(L)	RW30H24W-1GH(L)
RW36H24W-1GH(L)	RW48H24W-1GH(L)

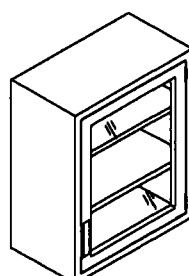

GLASS W/ FRAME HINGED RIGHT:

RW24H18W-1GH(R)	RW30H18W-1GH(R)
RW36H18W-1GH(R)	RW48H18W-1GH(R)
RW24H24W-1GH(R)	RW30H24W-1GH(R)
RW36H24W-1GH(R)	RW48H24W-1GH(R)

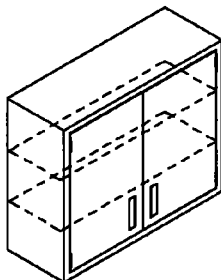

STEEL DOORS - HINGED:

RW24H30W-2SH	RW36H30W-2SH
RW24H36W-2SH	RW36H36W-2SH
RW24H42W-2SH	RW36H42W-2SH
RW24H48W-2SH	RW36H48W-2SH
RW30H30W-2SH	RW48H30W-2SH
RW30H36W-2SH	RW48H36W-2SH
RW30H42W-2SH	RW48H42W-2SH
RW30H48W-2SH	RW48H48W-2SH

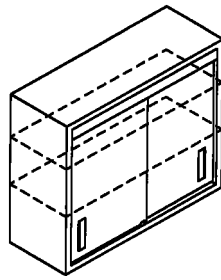

STEEL DOORS - SLIDING:

RW24H30W-2SS	RW36H30W-2SS
RW24H36W-2SS	RW36H36W-2SS
RW24H42W-2SS	RW36H42W-2SS
RW24H48W-2SS	RW36H48W-2SS
RW30H30W-2SS	RW48H30W-2SS
RW30H36W-2SS	RW48H36W-2SS
RW30H42W-2SS	RW48H42W-2SS
RW30H48W-2SS	RW48H48W-2SS

WALL CASE UNITS

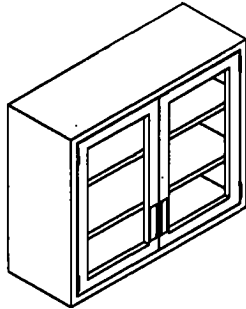

GLASS W/ FRAME – HINGED:

- RW24H30W-2GH W36H30W-2GH
- RW24H36W-2GH W36H36W-2GH
- RW24H42W-2GH W36H42W-2GH
- RW24H48W-2GH W36H48W-2GH
- RW30H30W-2GH W48H30W-2GH
- RW30H36W-2GH W48H36W-2GH
- RW30H42W-2GH W48H42W-2GH
- RW30H48W-2GH W48H48W-2GH

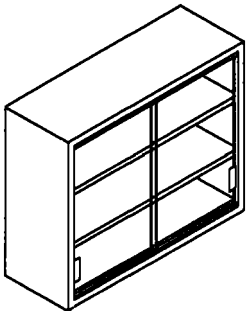

GLASS DOORS – SLIDING:

- RW24H30W-2GS W36H30W-2GS
- RW24H36W-2GS W36H36W-2GS
- RW24H42W-2GS W36H42W-2GS
- RW24H48W-2GS W36H48W-2GS
- RW30H30W-2GS W48H30W-2GS
- RW30H36W-2GS W48H36W-2GS
- RW30H42W-2GS W48H42W-2GS
- RW30H48W-2GS W48H48W-2GS

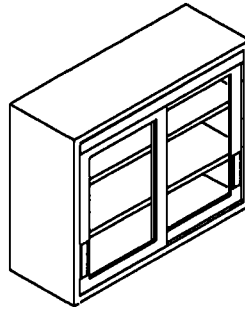

GLASS W/ FRAME – SLIDING:

- RW24H30W-2GSF R W36H30W-2GSF
- RW24H36W-2GSF R W36H36W-2GSF
- RW24H42W-2GSF R W36H42W-2GSF
- RW24H48W-2GSF R W36H48W-2GSF
- RW30H30W-2GSF R W48H30W-2GSF
- RW30H36W-2GSF R W48H36W-2GSF
- RW30H42W-2GSF R W48H42W-2GSF
- RW30H48W-2GSF R W48H48W-2GSF

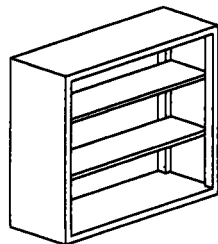

PASS-THRU (OPEN ON TWO SIDES)

- RWDS30H30W-00013 open-2-s
- RWDS30H36W-00013 open-2-s
- RWDS30H48W-00013 open-2-s

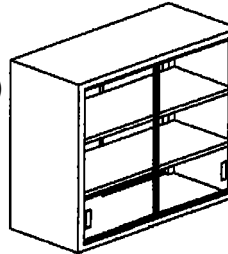

PASS-THRU (OPEN ON TWO SIDES)

- RWDS30H36W-4GS13 open-2-s
- RWDS30H48W-4GS13 open-2-s

CORNER WALL CASE UNITS

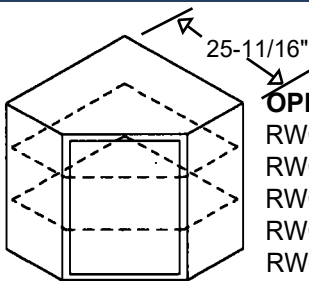

OPEN SHELVING:

- RWC24H18W-000
- RWC30H18W-000
- RWC36H18W-000
- RWC30H18W-00016
- RWC36H18W-00016

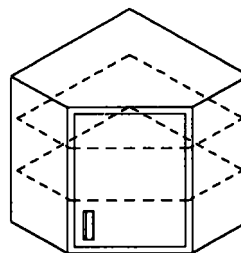

STEEL DOOR – HINGED:

- RWC24H18W-1SH(RorL)
- RWC30H18W-1SH(RorL)
- RWC36H18W-1SH(RorL)
- RWC30H18W-1SH(RorL)16
- RWC36H18W-1SH(RorL)16

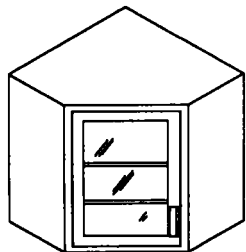

GLASS DOOR W/ FRAME:

- RWC24H18W-1GH(L)
- RWC30H18W-1GH(L)
- RWC36H18W-1GH(L)
- RWC30H18W-1GH(L)16
- RWC36H18W-1GH(L)16

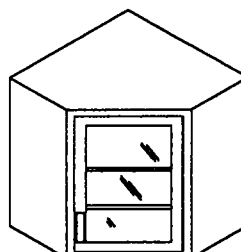

GLASS DOOR W/ FRAME:

- RWC24H18W-1GH(R)
- RWC30H18W-1GH(R)
- RWC36H18W-1GH(R)
- RWC30H18W-1GH(R)16
- RWC36H18W-1GH(R)16

NOTE: When ordering units with configurations that are non-standard, drawings must accompany order.
NOTE: 16" deep corner wall case dimension = 28-11/16"

FLOOR CASE UNITS

Floor cases are available in widths ranging from 18" to 48". All units are 84" high and are available in either 16" or 21-1/4" depths. Five shelves are standard equipment. Additional shelves are available. single hinge door units, specify (R) or (L) hinge.

Part Numbering System

Sample: RF84H18W-2SS16 1= Floor Case 4= #Doors
 11222333-456 2= Height 5= Material of
 3= Width 6= Type of doors* *

- * Steel Glass or no doors (open)
- ** Hinged, Sliding or Sliding/framed
- * "R" = Right hinge facing cabinet
- * "L" = Left hinge facing cabinet

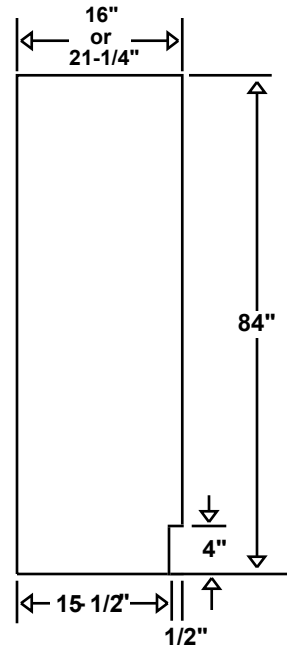

End View (16" Dp. Unit)

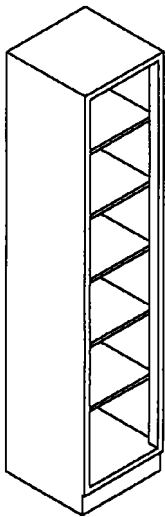

OPEN SHELVING:
 RF84H18W-00016
 RF84H18W-00021
 RF84H24W-00016
 RF84H24W-00021

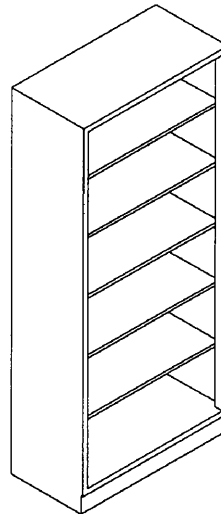

OPEN SHELVING:
 RF84H30W-00016
 RF84H30W-00021
 RF84H36W-00016
 RF84H36W-00021
 RF84H42W-00016
 RF84H42W-00021
 RF84H48W-00016
 RF84H48W-00021

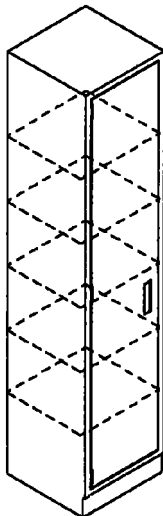

STEEL DOOR – HINGED LEFT:
 RF84H18W-1SH16(L)
 RF84H18W-1SH21(L)
 RF84H24W-1SH16(L)
 RF84H24W-1SH21(L)

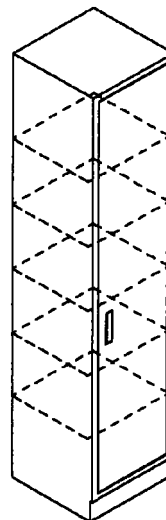

STEEL DOOR – HINGED RIGHT:
 RF84H18W-1SH16(R)
 RF84H18W-1SH21(R)
 RF84H24W-1SH16(R)
 RF84H24W-1SH21(R)

NOTE: When ordering units with configurations that are non-standard, drawings must accompany order.

FLOOR CASE UNITS

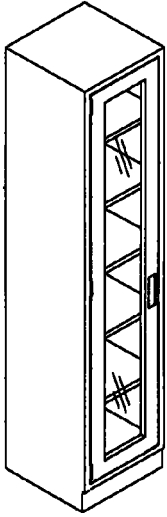

GLASS W/ FRAME – HINGED LEFT:

- RF84H18W-1GH16(L)
- RF84H18W-1GH21(L)
- RF84H24W-1GH16(L)
- RF84H24W-1GH21(L)

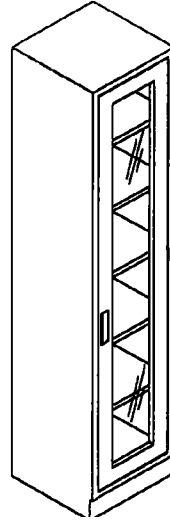

GLASS W/ FRAME – HINGED RIGHT:

- RF84H18W-1GH16(R)
- RF84H18W-1GH21(R)
- RF84H24W-1GH16(R)
- RF84H24W-1GH21(R)

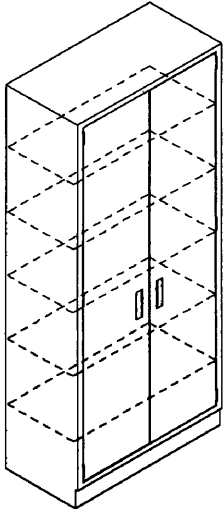

STEEL DOORS – HINGED:

- RF84H30W-2SH16
- RF84H30W-2SH21
- RF84H36W-2SH16
- RF84H36W-2SH21
- RF84H42W-2SH16
- RF84H42W-2SH21
- RF84H48W-2SH16
- RF84H48W-2SH21

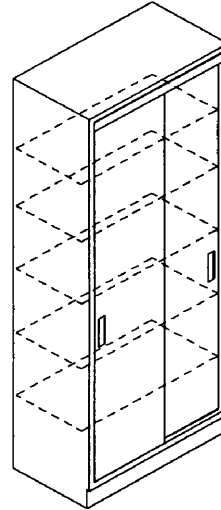

STEEL DOORS – SLIDING:

- RF84H30W-2SS16
- RF84H30W-2SS21
- RF84H36W-2SS16
- RF84H36W-2SS21
- RF84H42W-2SS16
- RF84H42W-2SS21
- RF84H48W-2SS16
- RF84H48W-2SS21

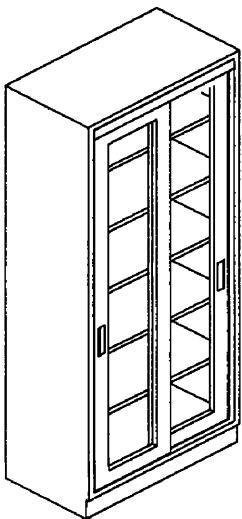

GLASS W/ FRAME – SLIDING:

- RF84H30W-2GSF16
- RF84H30W-2GSF21
- RF84H36W-2GSF16
- RF84H36W-2GSF21
- RF84H42W-2GSF16
- RF84H42W-2GSF21
- RF84H48W-2GSF16
- RF84H48W-2GSF21

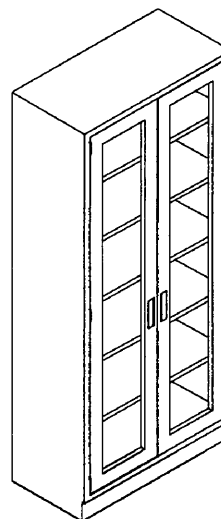

GLASS W/ FRAME – HINGED:

- RF84H30W-2GH16
- RF84H30W-2GH21
- RF84H36W-2GH16
- RF84H36W-2GH21
- RF84H42W-2GH16
- RF84H42W-2GH21
- RF84H48W-2GH16
- RF84H48W-2GH21

NOTE: When ordering units with configurations that are non-standard, drawings must accompany order.

FUME HOODS

QUALITY

The name RDM has long been synonymous with quality and longevity. Our newly redesigned fume hood line is a proud example of this reputation. We are backed with over 50 years of experience, combined with state of the art engineering, manufacturing and testing facilities to provide you with a top quality fume hood solution unsurpassed in quality and performance.

DESIGN

The design of our fume hood line is founded on three basic principals: safety, flexibility and aesthetics.

SAFETY

Safety should be the number one concern when choosing a fume hood. That is why our hoods are tested and certified in accordance with the Ashrae method of testing performance of laboratory fume hoods.

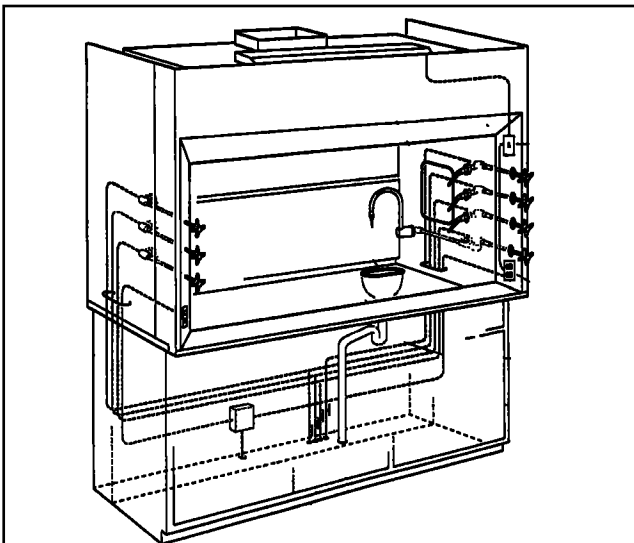

FLEXIBILITY

Construction of our fume hood begins with a heavy duty internal framework. This universal framework is the foundation for a variety of standard and optional features.

These features include. . .

- Chemical resistant interiors of resin-chem, PVC or stainless steel
- PVC or stainless sash guides
- Vertical, horizontal or combination sashes in a variety of materials
- Easy access for service fixture installation
- Manual or remote baffle adjustment
- Fluorescent light fixture
- Optional factory installation of service fixtures

The flexibility of our design will allow you to select standard options that will meet the requirements of your application.

AESTHETICS

Our quality, pride and craftsmanship will insure that your RDM Fume Hood will be a handsome center piece in your laboratory for years to come.

CATALOG

For a complete fume hood catalog contact your local RDM representative or contact us direct at the following address:

RDM Industrial Products, Inc.
1652 Watson Court
Milpitas, CA 95035
PH: (408) 945-8400
FX: (408) 945-8433

FUME HOODS

**BYPASS & VARIABLE
AIR VOLUME (VAV)
FUME HOODS**

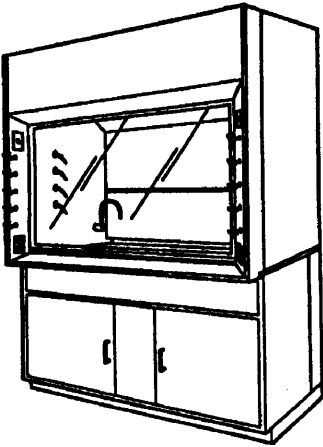
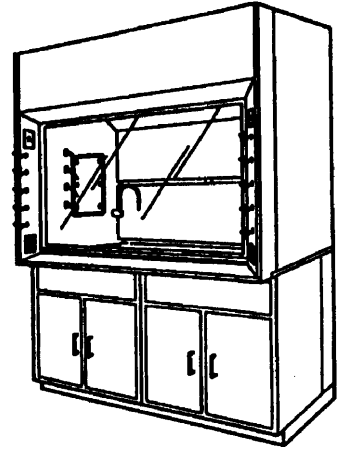

**PERCHLORIC ACID AND
RADIO-ISOTOPE FUME HOODS**

ADA FUME HOODS

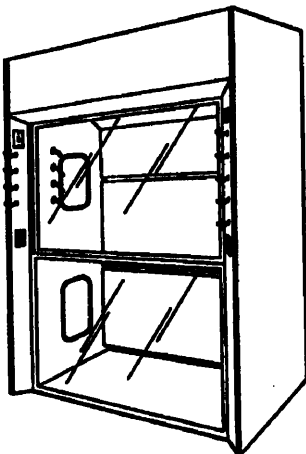
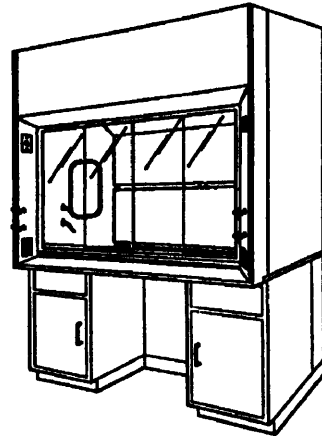

**WALK-IN AND SPECIAL
FUME HOODS**

APRONS AND DRAWER HOUSINGS

Part Numbering System: RA04H60W22D-000 1= Apron 4= Depth
 11222333444-555 2= Height 5= # Drawers
 3= Width

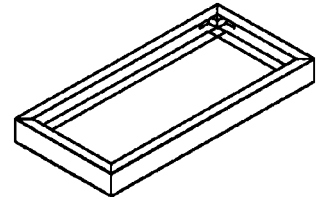

- | | |
|-----------------|-----------------|
| RA04H24W22D-000 | RA04H24W28D-000 |
| RA04H30W22D-000 | RA04H30W28D-000 |
| RA04H36W22D-000 | RA04H36W28D-000 |
| RA04H42W22D-000 | RA04H42W28D-000 |
| RA04H48W22D-000 | RA04H48W28D-000 |
| RA04H54W22D-000 | RA04H54W28D-000 |
| RA04H60W22D-000 | RA04H60W28D-000 |
| RA04H66W22D-000 | RA04H66W28D-000 |
| RA04H72W22D-000 | RA04H72W28D-000 |

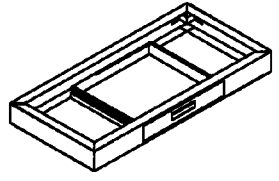

- | | |
|-----------------|-----------------|
| RA04H24W22D-001 | RA04H24W28D-001 |
| RA04H30W22D-001 | RA04H30W28D-001 |
| RA04H36W22D-001 | RA04H36W28D-001 |
| RA04H42W22D-001 | RA04H42W28D-001 |

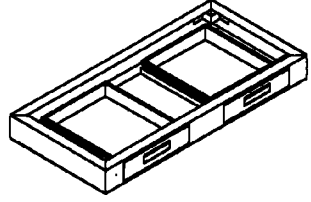

- | | |
|-----------------|-----------------|
| RA04H42W22D-002 | RA04H42W28D-002 |
| RA04H48W22D-002 | RA04H48W28D-002 |
| RA04H54W22D-002 | RA04H54W28D-002 |
| RA04H60W22D-002 | RA04H60W28D-002 |
| RA04H66W22D-002 | RA04H66W28D-002 |
| RA04H72W22D-002 | RA04H72W28D-002 |

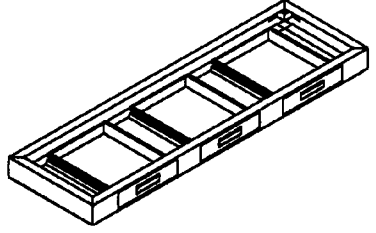

- | | |
|-----------------|-----------------|
| RA04H72W22D-003 | RA04H72W28D-003 |
|-----------------|-----------------|

Note: Apron heights are 4-1/2" high.

KNEE SPACE RAILS

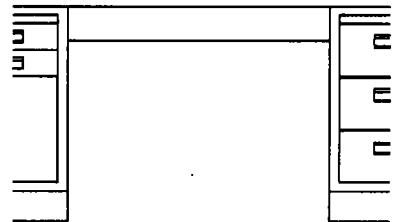

- | | |
|------------|------------|
| RKSR04H18W | RKSR04H52W |
| RKSR04H24W | RKSR04H54W |
| RKSR04H30W | RKSR04H60W |
| RKSR04H36W | RKSR04H66W |
| RKSR04H42W | RKSR04H72W |
| RKSR04H48W | RKSR04H84W |
| | RKSR04H96W |

NOTE: When ordering units with configurations that are non-standard, drawings must accompany order.

UTILITY TABLES AND COMPONENTS

29" HIGH TABLES

35" HIGH TABLES

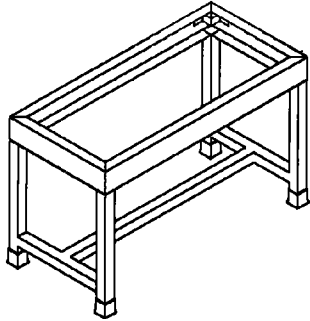

22" DEEP

RUT29H24W22D-000
RUT29H30W22D-000
RUT29H36W22D-000
RUT29H42W22D-000
RUT29H48W22D-000
RUT29H60W22D-000
RUT29H72W22D-000

28" DEEP

RUT29H24W28D-000
RUT29H30W28D-000
RUT29H36W28D-000
RUT29H42W28D-000
RUT29H48W28D-000
RUT29H60W28D-000
RUT29H72W28D-000

22" DEEP

RUT35H24W22D-000
RUT35H30W22D-000
RUT35H36W22D-000
RUT35H42W22D-000
RUT35H48W22D-000
RUT35H60W22D-000
RUT35H72W22D-000

28" DEEP

RUT35H24W28D-000
RUT35H30W28D-000
RUT35H36W28D-000
RUT35H42W28D-000
RUT35H48W28D-000
RUT35H60W28D-000
RUT35H72W28D-000

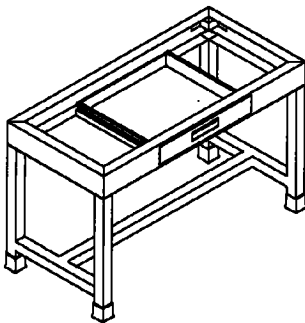

22" DEEP

RUT29H24W22D-001
RUT29H30W22D-001
RUT29H36W22D-001
RUT29H42W22D-001

28" DEEP

RUT29H24W28D-001
RUT29H30W28D-001
RUT29H36W28D-001
RUT29H42W28D-001

22" DEEP

RUT35H24W22D-001
RUT35H30W22D-001
RUT35H36W22D-001
RUT35H42W22D-001

28" DEEP

RUT35H24W28D-001
RUT35H30W28D-001
RUT35H36W28D-001
RUT35H42W28D-001

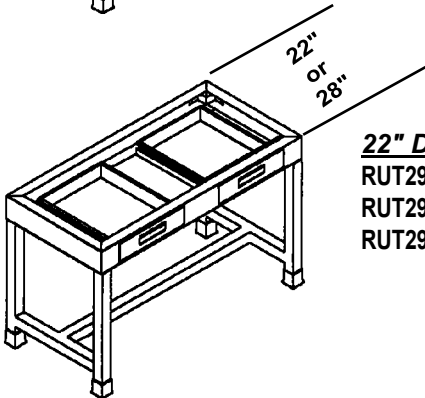

22" DEEP

RUT29H48W22D-002
RUT29H60W22D-002
RUT29H72W22D-002

28" DEEP

RUT29H48W28D-002
RUT29H60W28D-002
RUT29H72W28D-002

22" DEEP

RUT35H48W22D-002
RUT35H60W22D-002
RUT35H72W22D-002

28" DEEP

RUT35H48W28D-002
RUT35H60W28D-002
RUT35H72W28D-002

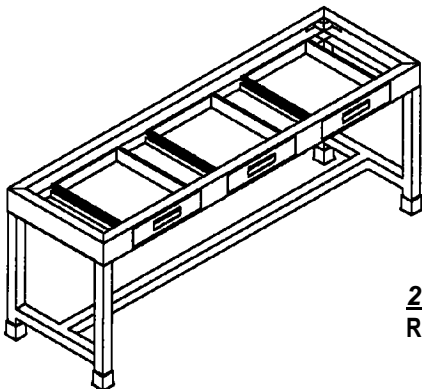

22" DEEP

RUT29H72W22D-003

28" DEEP

RUT29H72W28D-003

22" DEEP

RUT35H72W22D-003

28" DEEP

RUT35H72W28D-003

NOTE: UTILITY TABLES DO NOT INCLUDE COUNTER TOPS. 2" SQ. LEGS, BLACK VINYL BOOTS.

NOTE: When ordering units with configurations that are non-standard, **drawings must accompany order.**

ACCESSORIES

TABLE LEGS

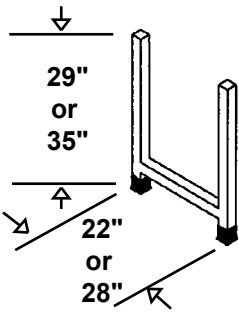

RL29H-22D
RL35H-22D
RL29H-28D
RL35H-28D

SINGLE LEG



RSL-29H
RSL-35H

SINGLE LEG WITH PLATE

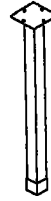

RSL-29HP
RSL-35HP

END PEDESTAL

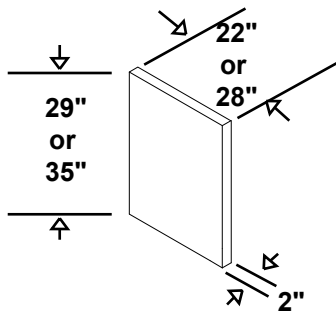

REP29H02W-22D
REP35H02W-22D
REP29H02W-28D
REP35H02W-28D

WALL CASE (UPPER CAB) FRONT FILLER

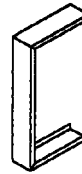

Specify Width (W)
RWCFF24H-W
RWCFF30H-W
RWCFF36H-W
RWCFF48H-W

WALL CASE CORNER FILLER

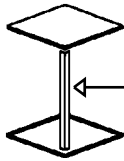

Specify Depth (D)
13" or 16"

RWCCF24H-D
RWCCF30H-D
RWCCF36H-D
RWCCF48H-D

Angle is 1"

REAGENT SHELF UPRIGHT

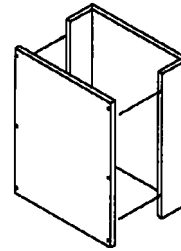

RRSU18H12D2W
(18"Hx12"Dx2"W)

Note: Special heights & options available upon request. Drawings and dimensions must accompany order.

WALL - FLOOR CASE SHELF

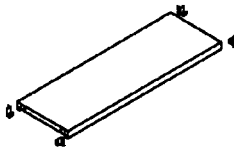

NOTE: Use with RSF Fascia Panels for Lateral Top Support (Not Shown) - Mounts between Uprights.

SLOPE TOP WITH END CAPS

PART NUMBERS

PART NUMBERS

WALL

RWS18W13D
RWS24W13D
RWS30W13D
RWS36W13D
RWS42W13D
RWS48W13D
RWS18W16D
RWS24W16D
RWS30W16D
RWS36W16D
RWS42W16D
RWS48W16D

FLOOR

RFS18W16D
RFS24W16D
RFS30W16D
RFS36W16D
RFS42W16D
RFS48W16D
RFS18W21D
RFS24W21D
RFS30W21D
RFS36W21D
RFS42W21D
RFS48W21D

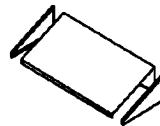

RST13D-18W RST21D-18W
RST13D-24W RST21D-24W
RST13D-30W RST21D-30W
RST13D-36W RST21D-36W
RST13D-42W RST21D-42W
RST13D-48W RST21D-48W
RST16D-18W
RST16D-24W
RST16D-30W
RST16D-36W
RST16D-42W
RST16D-48W

NOTE: When ordering units with configurations that are non-standard, drawings must accompany order.

ACCESSORIES

KNEE SPACE PANELS

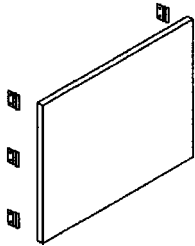

For use in sit down situation with apron

24" HIGH

RKSP24H24W
RKSP24H30W
RKSP24H36W
RKSP24H42W
RKSP24H48W
RKSP24H54W
RKSP24H60W
RKSP24H66W
RKSP24H72W

For use in standing situation with apron, or sit down without apron

29" HIGH

RKSP29H24W
RKSP29H30W
RKSP29H36W
RKSP29H42W
RKSP29H48W
RKSP29H54W
RKSP29H60W
RKSP29H66W
RKSP29H72W

For use in standing situation without apron

35" HIGH

RKSP35H24W
RKSP35H30W
RKSP35H36W
RKSP35H42W
RKSP35H48W
RKSP35H54W
RKSP35H60W
RKSP35H66W
RKSP35H72W

FILL PANELS

All base cabinet fillers are 35" high. Fillers for 29" high (low base) cabinets will need to be trimmed by the installer. Other sizes available upon request.



C-FILLER

RCF35-8W
RCF35-14W

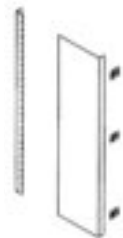

L-FILLER

RLF35-1W
RLF35-7W
RLF35-11W

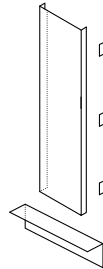

C-FRONT FILLER

RFFC35-8W
RFFC35-14W



CORNER FILLER

RICF35H-1W
RICF35H-2W
RICF35H-4W



L-FRONT FILLER

RFFL35H-8W
RFFL35H-14W



FLOOR CASE FILLER

RFFL84H-2W
RFFL84H-8W



TOE SPACE FILLER

RTSF-00 (WIDTH)

* Last number(s) in filler designation indicates width of filler assembly.



Represented By:



RDM LABORATORY FURNITURE SOLUTIONS

1652 Watson Court

Milpitas, CA 95035

Telephone: (408) 945-8400

FAX: (408) 945-8433

Web page: www.rdm-ind.com

E-mail: sales@rdm-ind.com

© RDM Industrial Products, Inc.

2019 Printed in the U.S.A.

QUALITY • SERVICE • TIMING